







PART NO 1100002

VT SHEET PILE CLAMP

Sponttving VT | VT Spundwandklemme

-  L: 146 mm
-  W: 52 mm
-  H: 175 mm
-  1,4 kg
-  Steel + Zn (electro galvanized)
-  EN13374 – A

-   1,24 × 0,84 × 0,97 m
-  770 kg
-  500 pcs

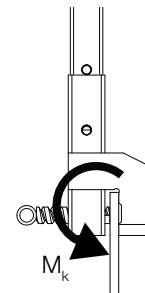
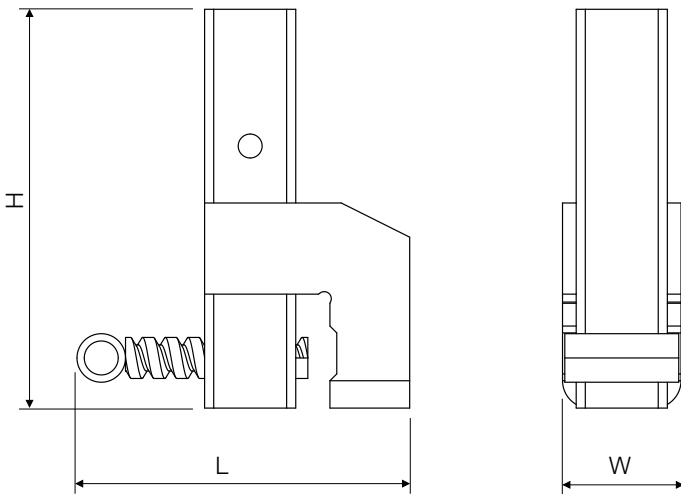
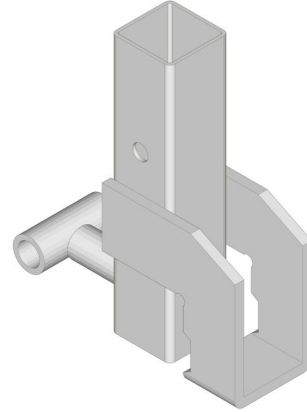

BENDING MOMENT (Q)¹ (Unfactored)

M_k	520 Nm
-------	--------

¹) Loads acc. to EN 13374:2013

$$Q_d \times \gamma_F^* = E_d \leq R_d = R_k / \gamma_M$$

* $\gamma_F = 1,5$

