











PART NO 5040034

# VT CLAMP 150

Tving 150 VT | VT Klemme 150 (Verbauklemme)

-  L: 330 mm
-  W: 180 mm
-  H: 249 mm
-  4,8 kg
-  Steel + Zn (hot dip galvanized)
-  EN13374 – A

-   1,24 × 0,84 × 0,97 m
-  550 kg
-  100 pcs

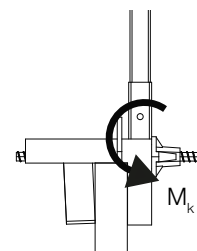
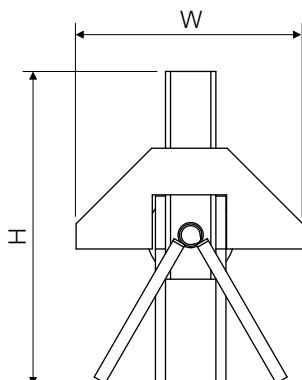
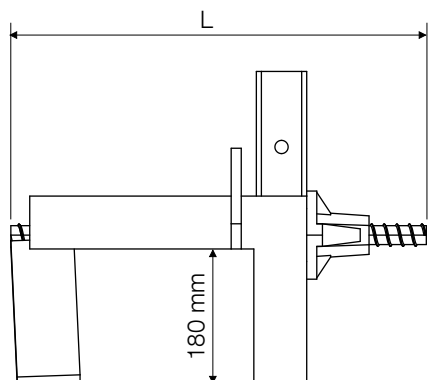
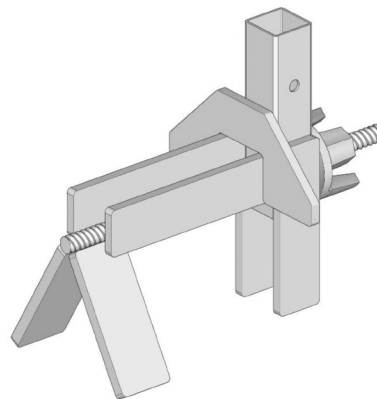

BENDING MOMENT (Q) <sup>1</sup> (Unfactored)	
M <sub>k</sub>	520 Nm
<sup>1</sup> ) Loads acc. to EN 13374:2013 $Q_{ki} \times \gamma_F^* = E_d \leq R_d = R_k / \gamma_M$ $\gamma_F^* = 1,5$	

